

**CORTE DEMONSTRATIVO**

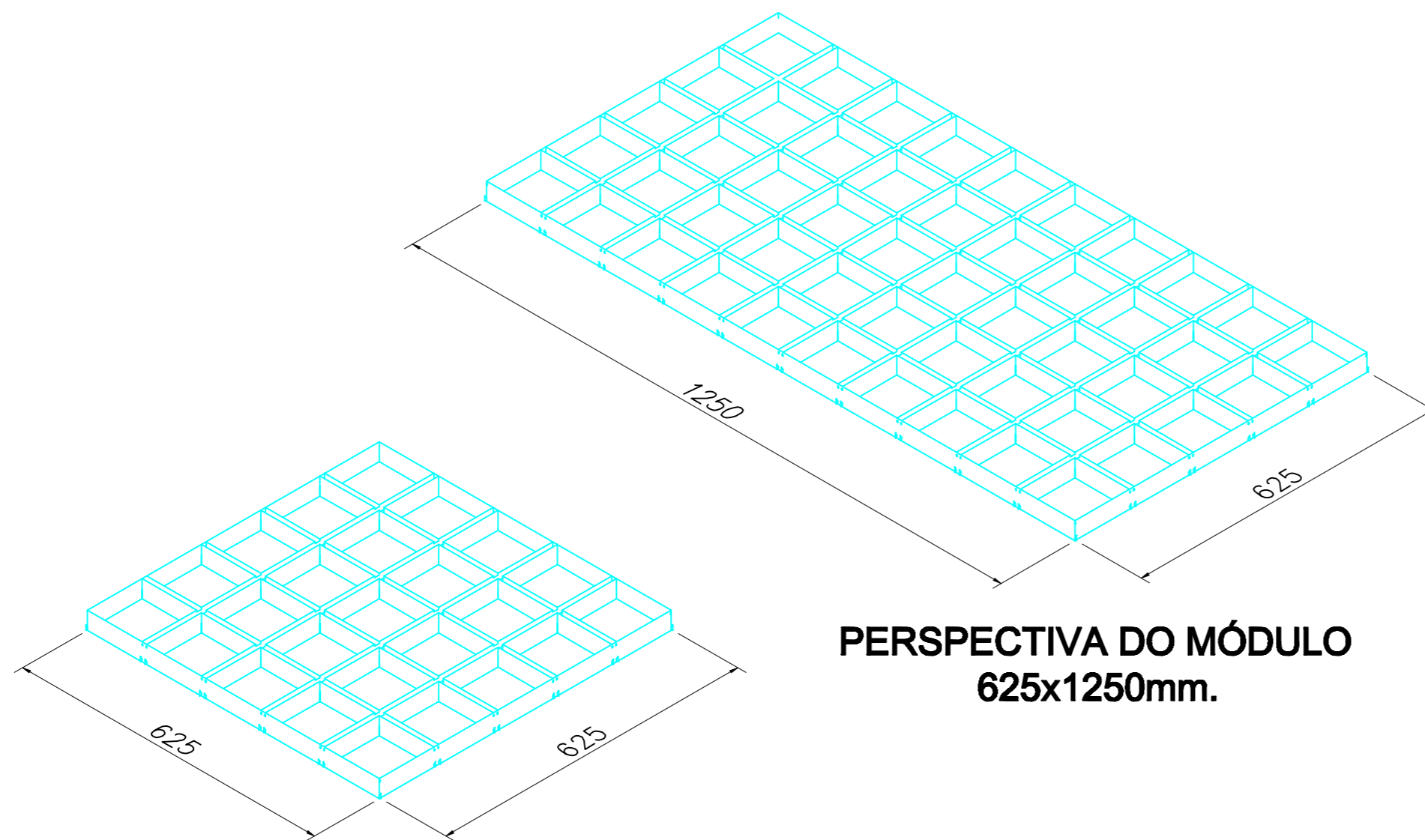

**PERSPECTIVA DO MÓDULO  
625x1250mm.**

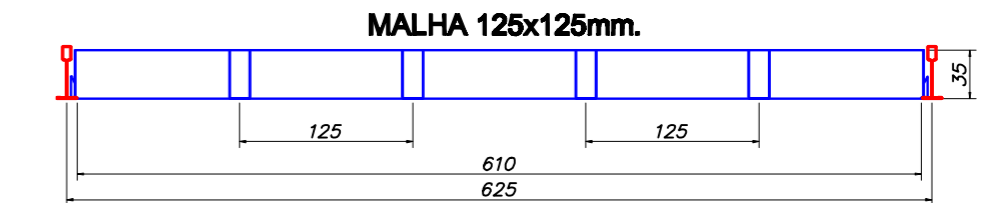
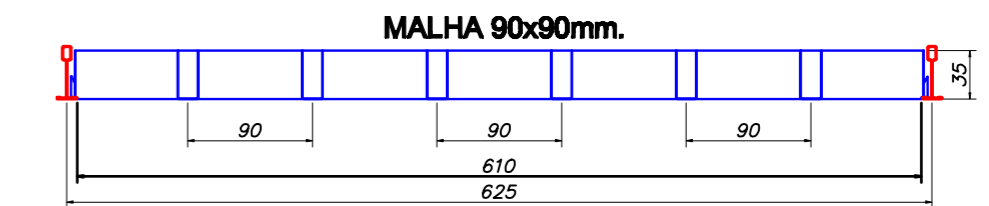
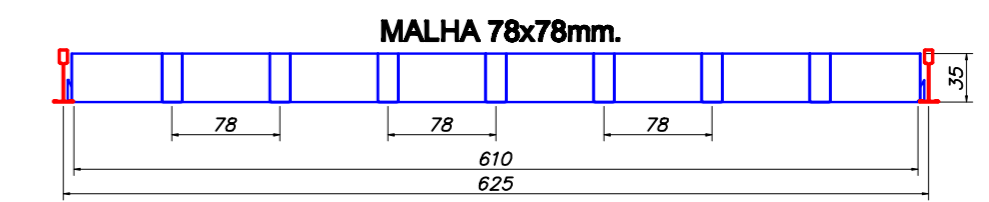
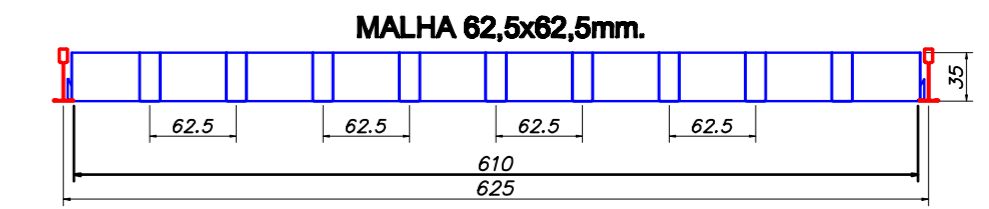
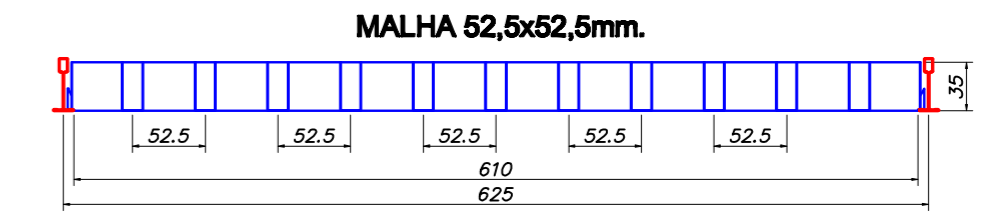
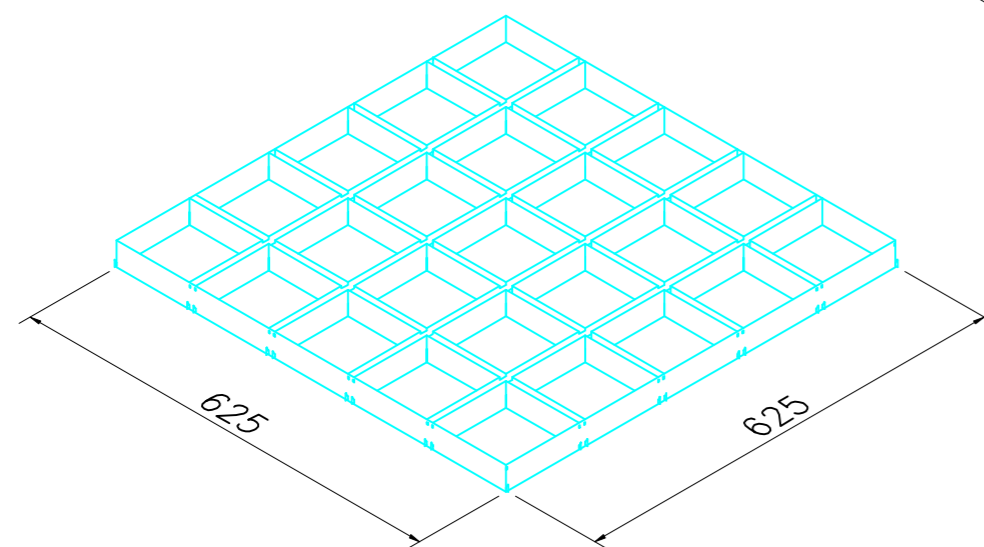

**PERSPECTIVA DO MÓDULO  
625x625mm.**

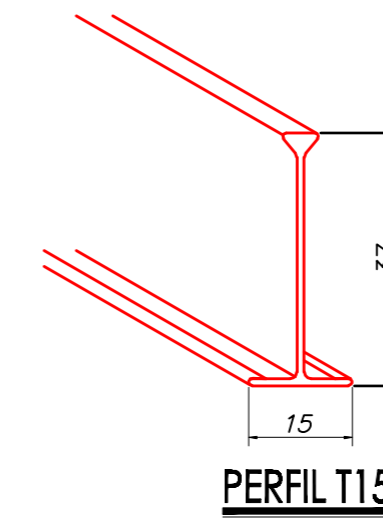

**PERFIL T15**

**NOTAS:**

1 - DIMENSÕES EM MILÍMETROS SALVO INDICAÇÃO CONTRÁRIA.

 <b>SUL METAIS</b>	Produto: <b>FORRO SM-T15</b>
	Aplicação: <b>FORRO</b>
	Desenho: <b>DETALHE, PERSPECTIVA E CORTES</b>
	Escala: <b>1:1, 1:5 e 1:8 / Perspectiva sem escala</b>